

TOP VIEW

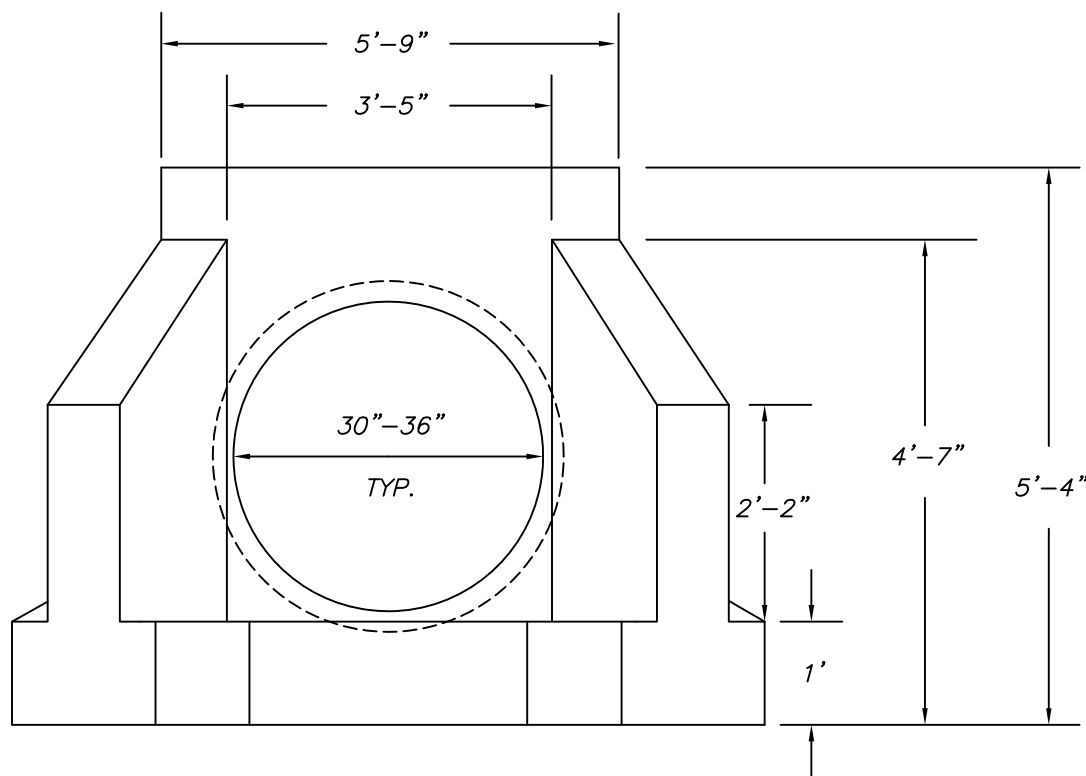

FRONT VIEW

NOTES :

1. MINIMUM 4,000 P.S.I. CONCRETE AT 28 DAYS WITH 5.5% A.E.
2. REINFORCEMENT—A.S.T.M. A615 GRADE 60, MINIMUM 1 1/2" COVER
3. ALL EXPOSED EDGES ARE CHAMFERED 1"
4. MATERIAL AND CONSTRUCTION SHALL COMPLY WITH PENN. D.O.T. PUB. 408
5. APPROX. WEIGHTS :
 30" = 8,500 LBS.
 33" = 8,325 LBS.
 36" = 8,150 LBS.

Precast Manufacturing Co. , LLC		
187 Strykers Road Phillipsburg , N.J. 08865		
Tel. (908) 454-2122 - Fax (908) 454-0512		
CONT.		
JOB		
DW ENDWALL-30" TO 36"		
WITH FOOTER ONLY		
DATE	DRAWN BY	DRAWING NO.
1 / 17	CLASSIC DESIGN	9-DW 30-36